

**WEIGHT
MULTI-HEAD
ELEKTRON-MHW-10**

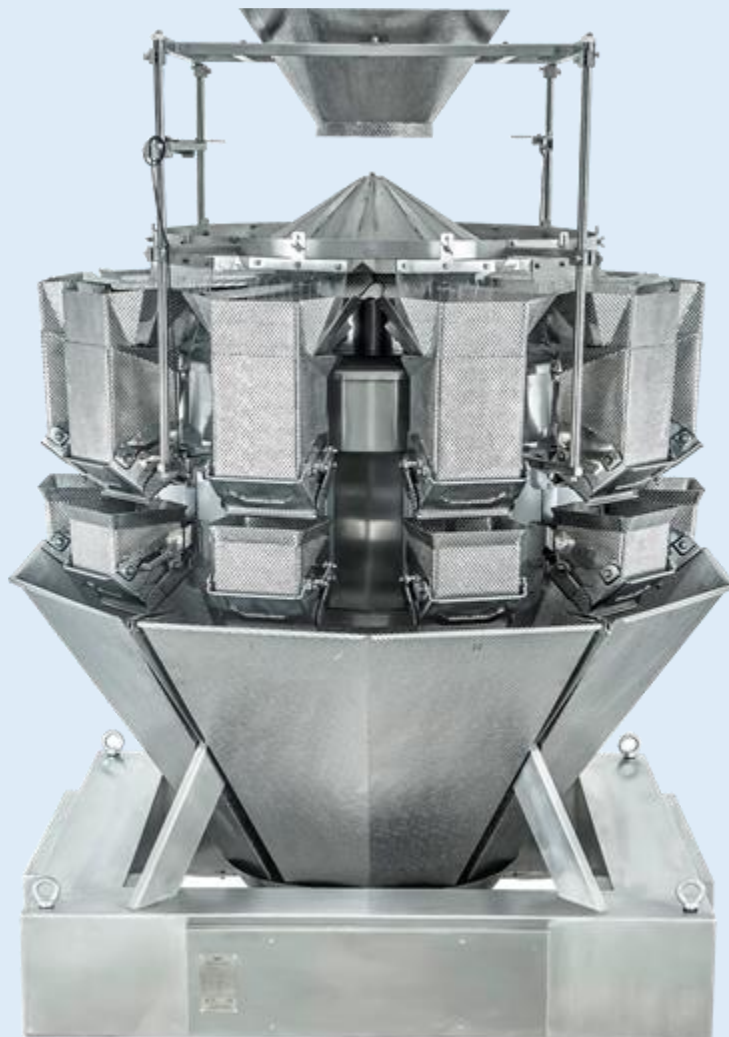

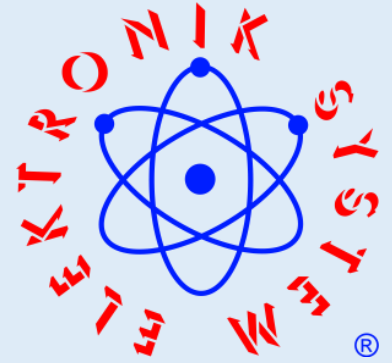

Ustronna 14
89-606 Charzykowy

wykrywaczmetali@onet.eu
elektron@metaldetektor.pl

+48 608 34 34 34



MULTI-HEAD SCALE SPECIFICATION

Model	MHW-10 1,6l	MHW-10 3,0l	MHW-10 5,5l	MHW-10 7,5l
Weighing chambers	1,6l one-sided tilting	3,0l	5,5l both side tilting	7,5l
Weighing range	15-1000g		25-5000g	
Deviation	± 0,5-2g		± 1-8g	
Max speed	to 70 portions per minute		to 60 portions per minute	
System considering	10 weighing sections			
Separation cone	Vibrating with strain gauge			
Control panel	10.4" Touchscreen			
Main features	<ol style="list-style-type: none"> 1. Accurate linear vibrators 2. Specialized weighing chamber 3. Central cone of the hopper with a strain gauge dosing the hopper capacity and product feeding 4. All automation elements of well-known, proven global brands available on the market 5. The system has been equipped with the latest generation software enabling LAN connection with a supervisory computer, USB output as well as the possibility of external supervision of the charging and contemplating system using an industrial camera, which facilitates the operation of one person 			
   Camera LAN connection USB output				
Housing material	SUS304 / SUS316			
Tightness class	IP64 / IP66			
Optional accessories	<ol style="list-style-type: none"> 1. Special perforation of the sheet to facilitate product discharge and hygiene 2. Specially formed bottom drop for improved machine performance 3. The use of SUS316 acid-resistant steel for the construction of the whole machine 			
Power	230V, 50Hz, 2,0KW			
Conditions of delivery	To be agreed			
Delivery time	100 working days from the date of payment of the advance			
Terms of payment	Advance payment of 50% of the gross price, 40% before delivery, the remaining 10% within 14 days from the date of handing over the subject of the contract			

LIST OF INDIVIDUAL COMPONENTS

Main board components	Main processor	Fujitsu - Japonia
	ROM memory	Cypress - USA
	RAM	Integrated Silicon Solution, Inc. - USA
	Communication	Sipex Corporation - USA
Display	CPU processor	Freescall - USA
	ROM memory	Spansion - USA
	RAM	Micron - USA
	Communication	ADI - Tajwan
Touchscreen	TFT 10.4 - inch	NEC Corporation - Japonia
Operation panel	Touchpad	Magic touch - Tajwan
Drive	Engine	SANYO - Japonia
		National Semiconductor - USA
Controllers	Slotted IR barriers	Toshiba - Japonia

TECHNICAL DRAWINGS OF A MULTI-HEAD BALANCE

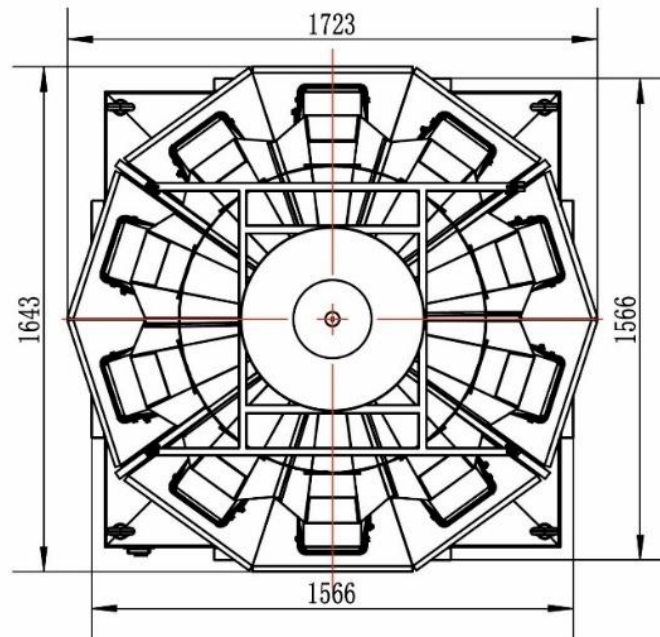
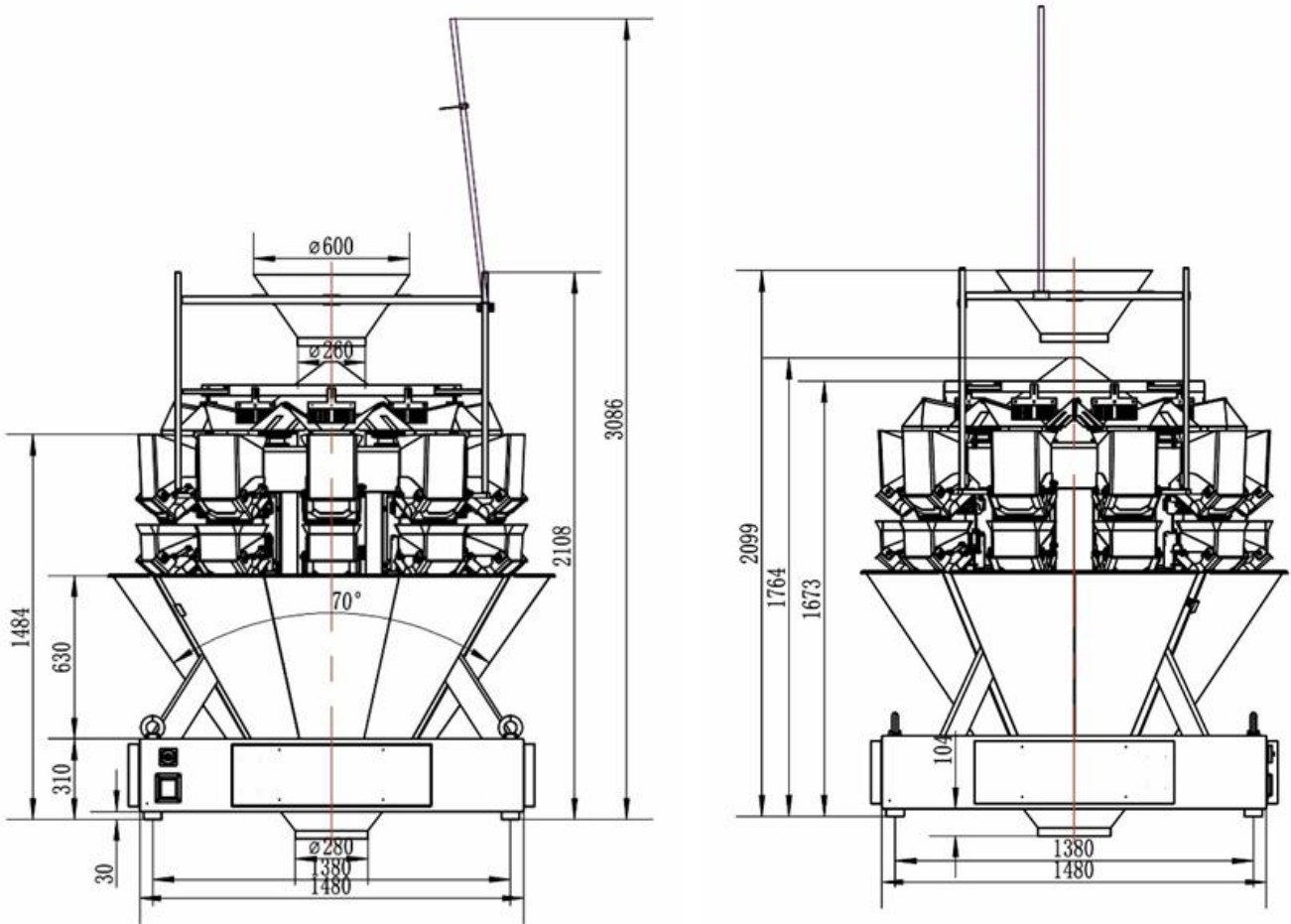
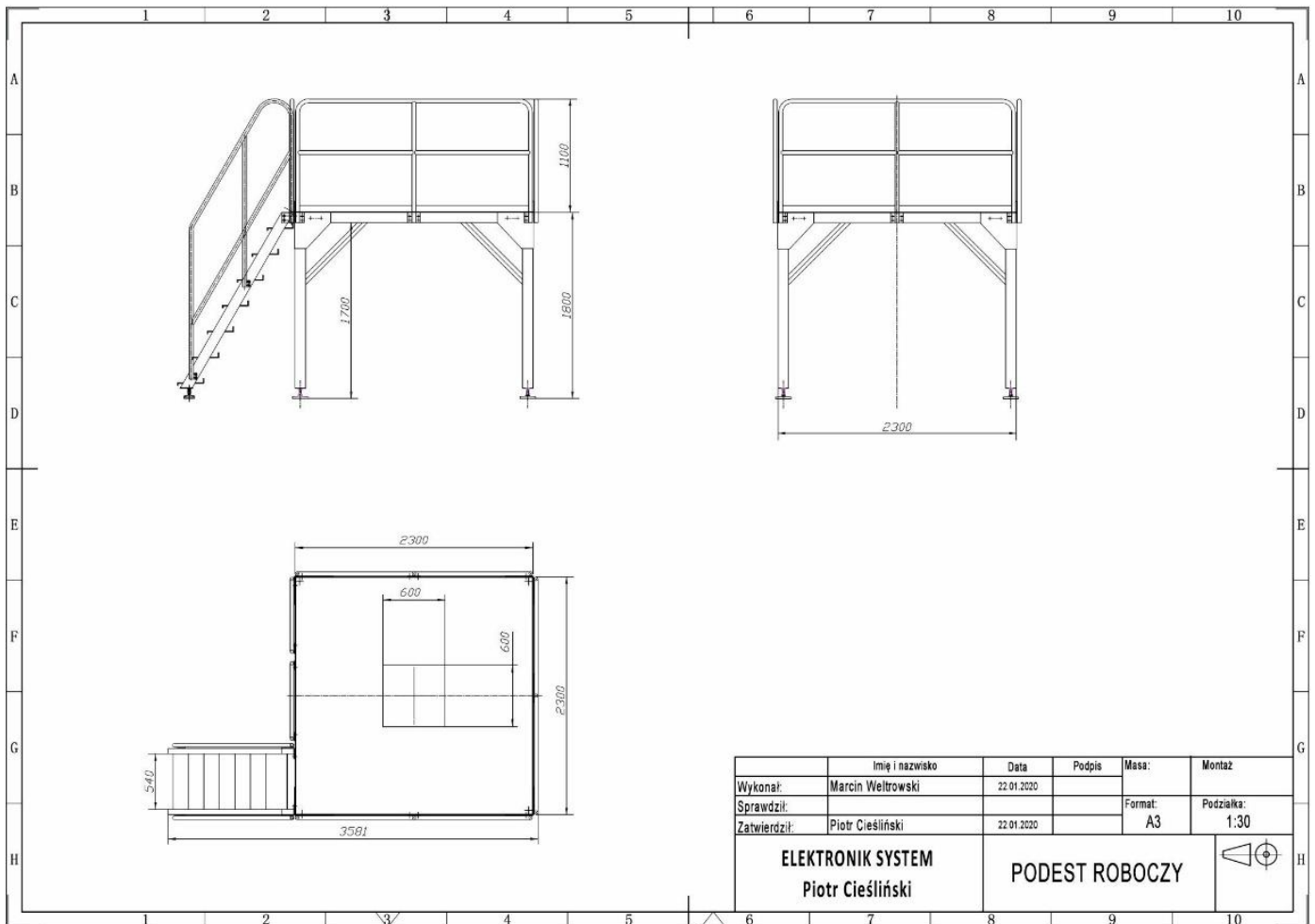

PHOTO OF THE WORKING PLATE PDR-150-316



TECHNICAL DRAWINGS OF THE WORKING PLATE



FEEDING TRANSPORTERS



Feed conveyor with modular belt



Delivery conveyor with polyurethane belt



Z-type feeding conveyor



Vibrorin dosing



RECEIVING ELEMENTS



Transporters collecting products from the packaging machine



Rotary table receiving products